

**ISTRUZIONI DI MONTAGGIO**

**ASSEMBLY INSTRUCTIONS**

**INSTRUCTIONS DE MONTAGE**

**MONTAGE ANLEITUNG**

**INSTRUCCIONES DE MONTAJE**

**ИНСТРУКЦИЯ ПО СБОРКЕ**

**SUPPORTO SCALA**

**SCALA STAND**

**SUPPORT SCALA**

**STÄNDER SCALA**

**SOPORTE SCALA**

**ПОДСТАВКА SCALA**



**Prima di usare il prodotto leggere attentamente le istruzioni contenute nel presente libretto. Star Progetti non potrà essere ritenuta responsabile per eventuali danni a persone o cose causati dal mancato rispetto delle indicazioni di seguito elencate, la cui osservanza assicurerà invece la durata e l'affidabilità, elettrica e meccanica, dell'apparecchio. Conservare sempre questo libretto d'istruzioni.**

**Read the instructions contained in this booklet carefully before using the appliance. Star Progetti cannot assume any responsibility for damage to property or personal injury resulting from failure to abide by the instructions given in this booklet. Following these instructions will ensure a long service life and overall electrical and mechanical reliability. Keep this instruction booklet in a safe place.**

**Avant d'utiliser le produit, lire attentivement les instructions contenues dans cette notice. La société Star Progetti ne pourra être tenue pour responsable des dommages éventuels causés aux personnes ou aux choses par suite du non respect des instructions ci-dessous. Le respect de toutes les indications reportées dans ce livret garantira une longue durée de vie ainsi que la fiabilité électrique et mécanique de l'appareil. Conserver toujours ce livret d'instructions.**

**Vor Installation und Anschluss dieses Produkts müssen die vorliegenden Anleitungen aufmerksam durchgelesen werden. Star Progetti kann nicht für Personen- oder Sachschäden zur Verantwortung gezogen werden, die auf eine Nichtbeachtung der Hinweise in dieser Betriebsanleitung zurückzuführen sind. Befolgen Sie alle Anweisungen, um eine lange Lebensdauer sowie die elektrische und mechanische Zuverlässigkeit des Geräts zu gewährleisten. Diese Betriebsanleitung ist gut aufzubewahren.**

**Antes de utilizar el producto, hay que leer atentamente las instrucciones de este folleto. Star Progetti no es responsable de los eventuales daños ocasionados a personas o cosas como resultado del incumplimiento de las indicaciones de este manual, las cuales garantizan la durabilidad y fiabilidad eléctrica y mecánica del aparato. Conservar este manual de instrucciones.**

**Перед использованием прочтите внимательно информацию, содержащуюся в настоящей инструкции. Star Progetti Group не несет ответственности за возможный вред, причиненный человеку или вещи из-за несоблюдения ниже перечисленных указаний, следование которым гарантирует надежность и продолжительность работы электрических и механических частей оборудования. Сохраните настоящую инструкцию.**



IT  
EN  
FR  
DE  
ES  
RU

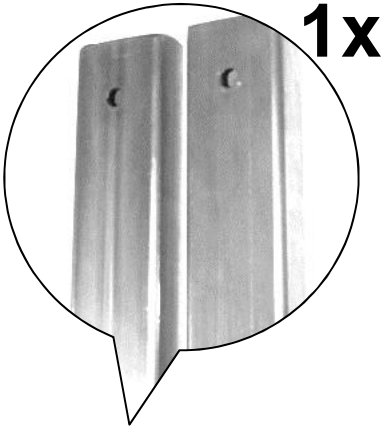

1x

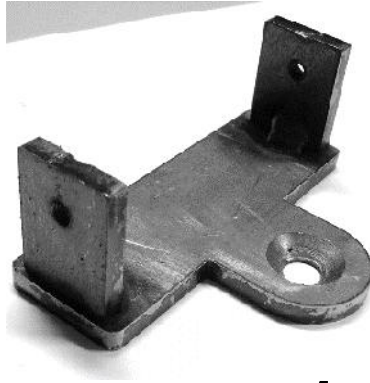

1x



5x

L= 950 mm, L1050 mm

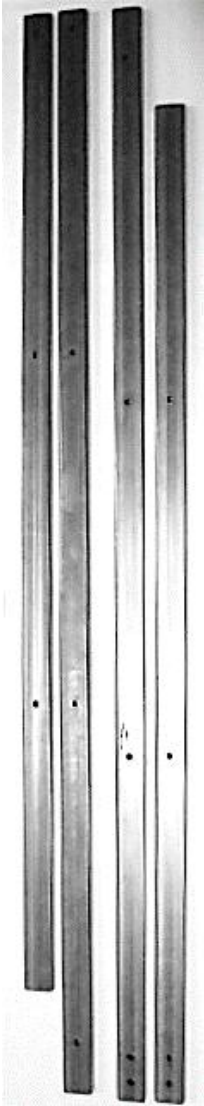

L= 950 mm, L1050 mm

1x

L= 150 mm



2x



2x

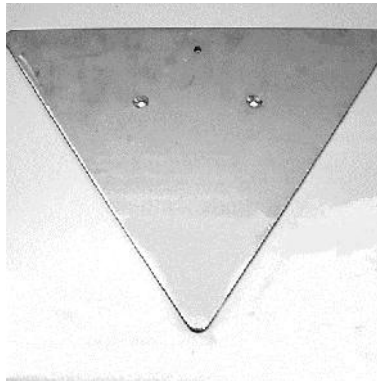

1x



N°3, N°5

1x



M5 x 25 TB

10x



M5 x 10 TB

6x



1x M8



M8 x 20 TS

3x



M8

2x

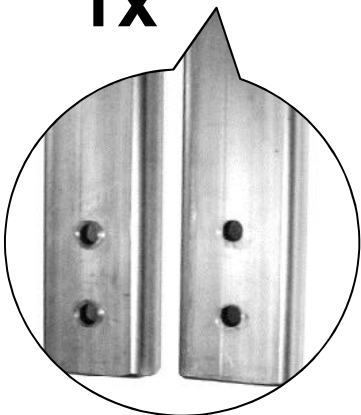

1

IT  
EN  
FR  
DE  
ES  
RU

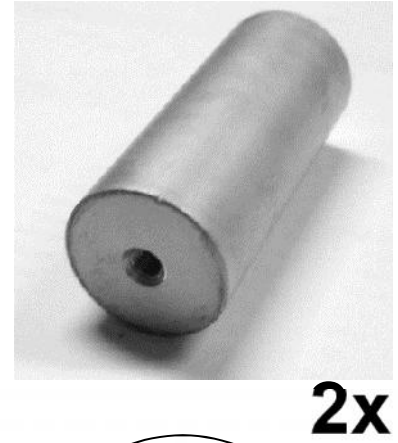
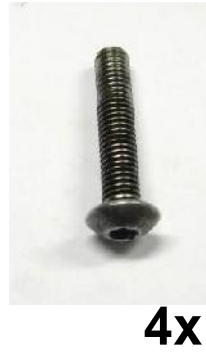
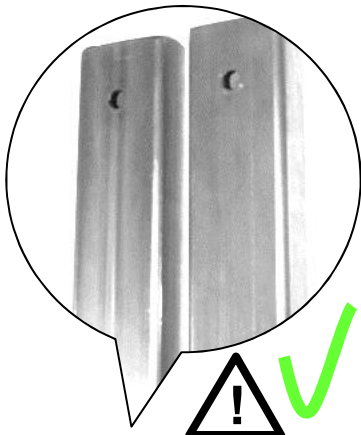

L= 950 mm, L1050 mm

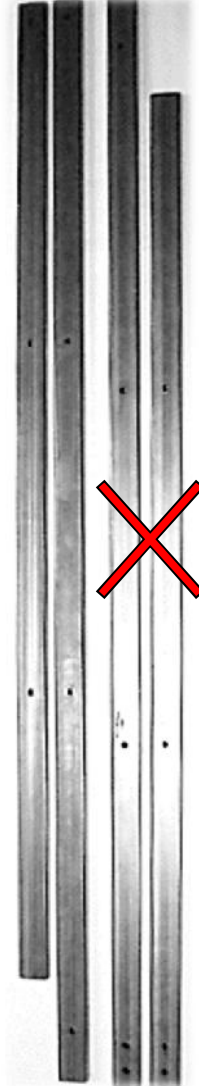

L= 950 mm, L1050 mm

1x

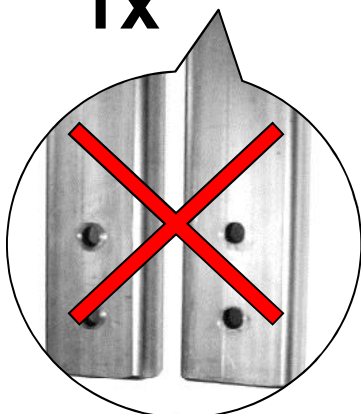
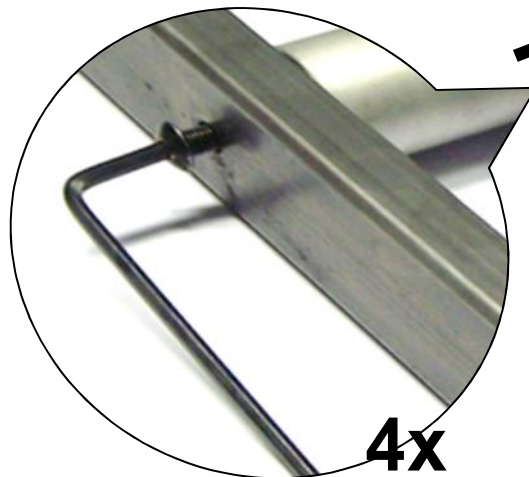
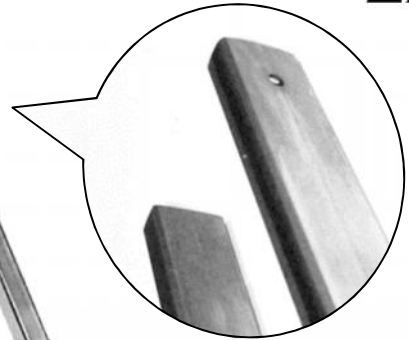
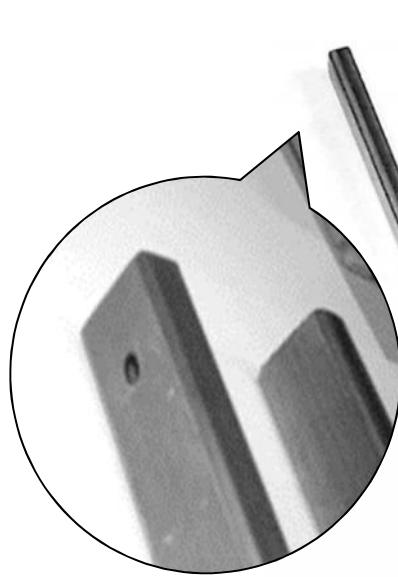

2

IT  
EN  
FR  
DE  
ES  
RU

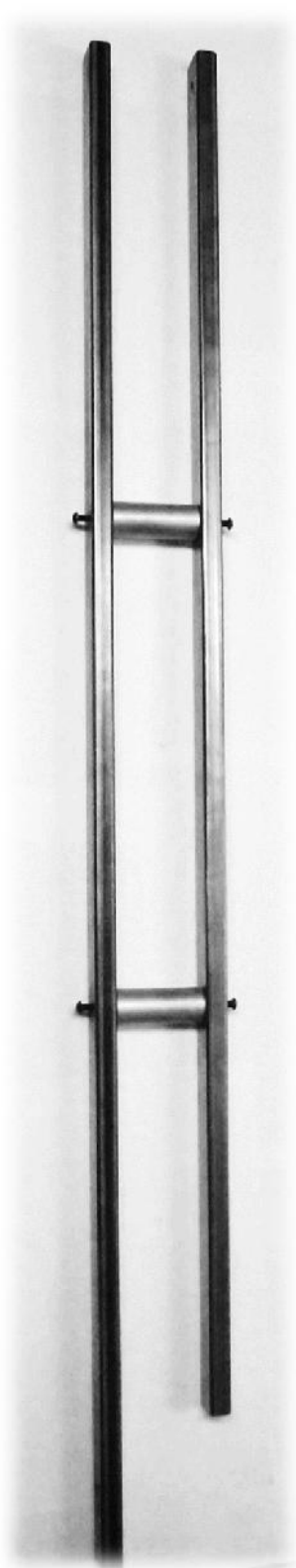

1x



1x



2x

M5 x 10 TB



1x



2x





# 3

IT  
EN  
FR  
DE  
ES  
RU

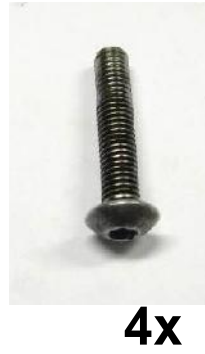
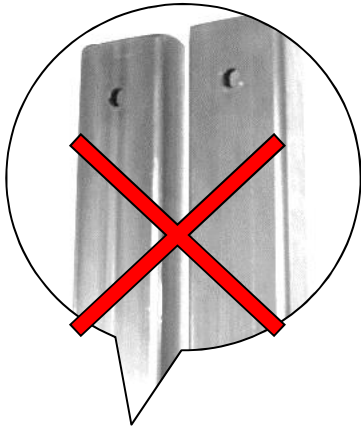

L= 950 mm, L 1050 mm



L= 950 mm, L 1050 mm

1x

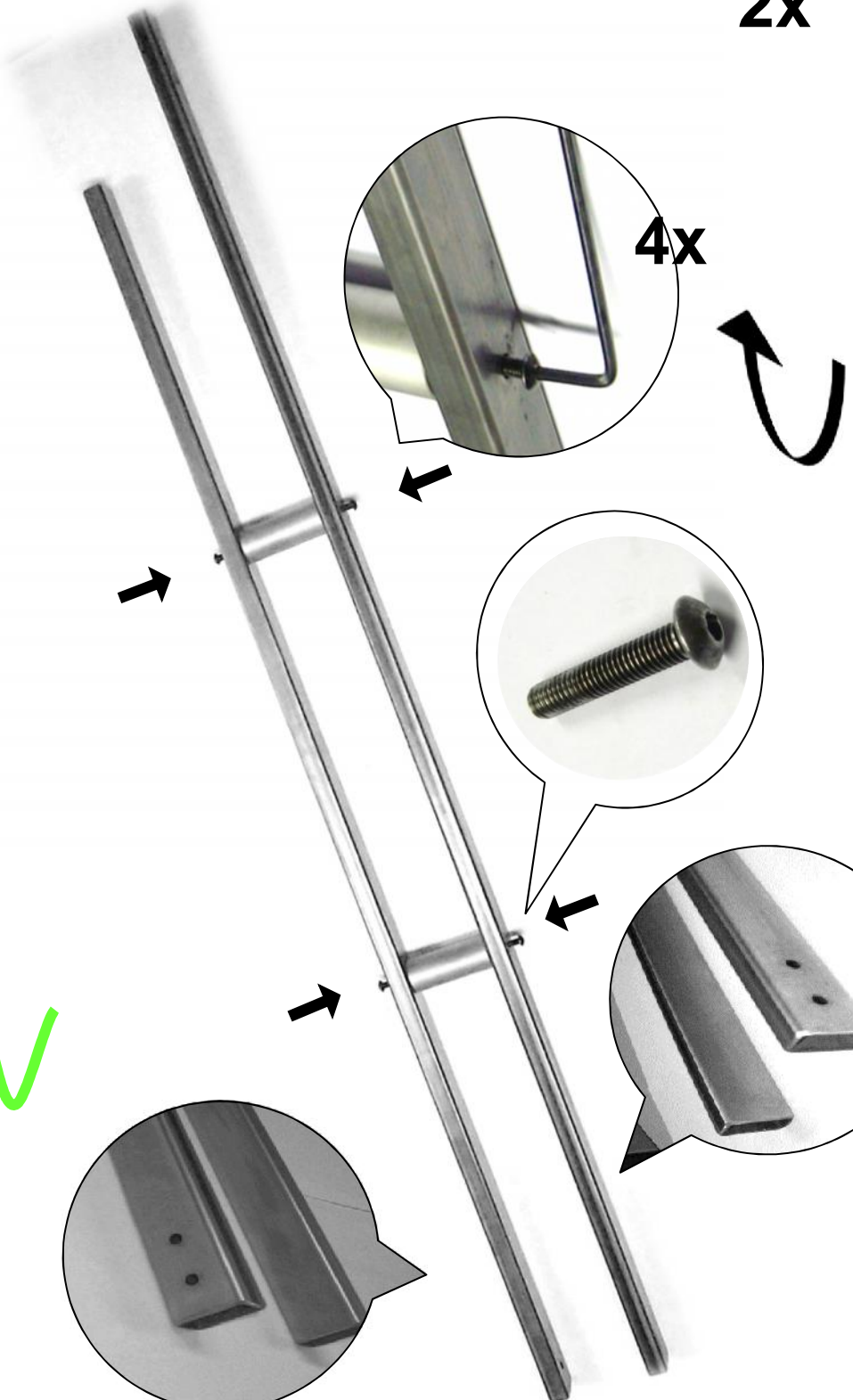
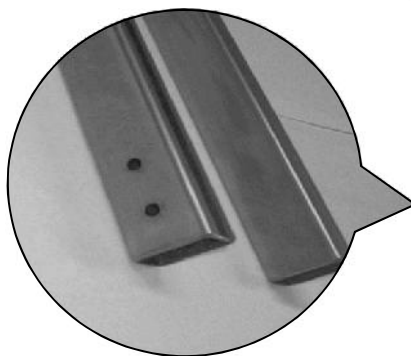
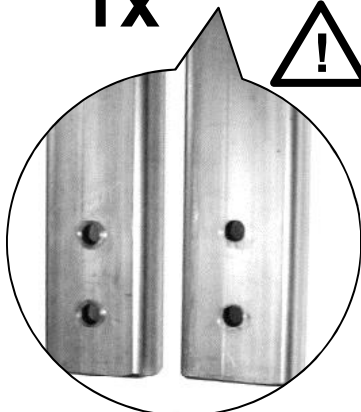

4x

4

IT  
EN  
FR  
DE  
ES  
RU

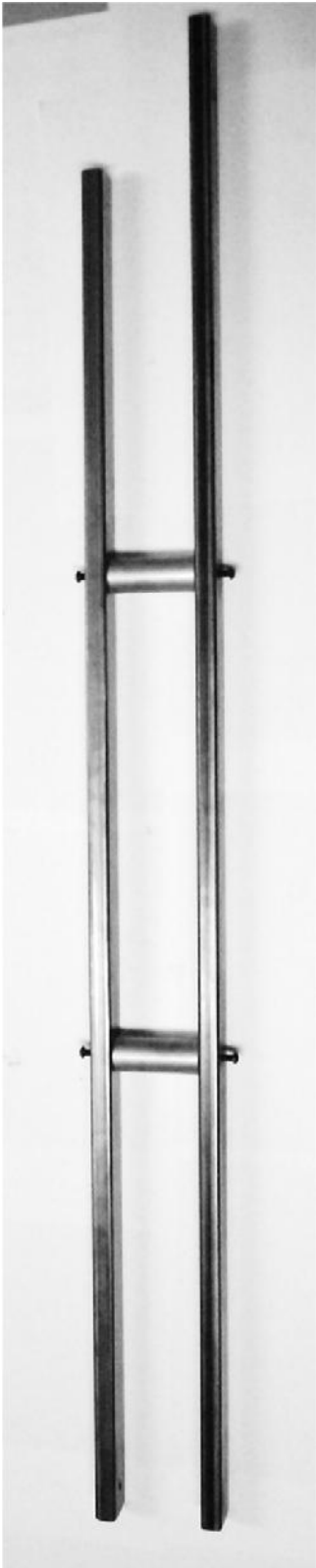

1x



M5 x 10 TB



2x

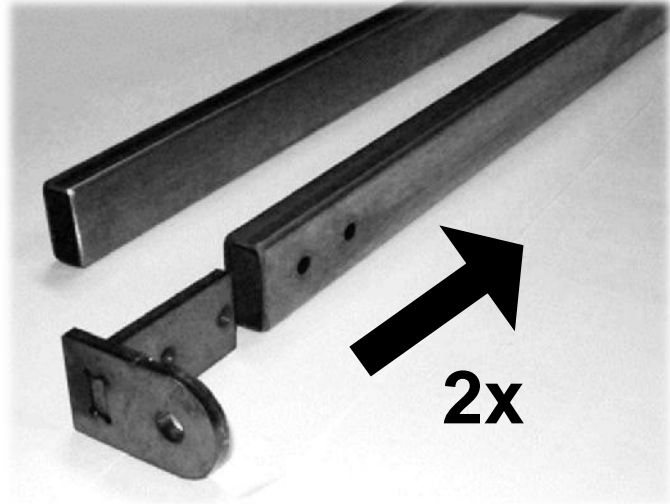

2x

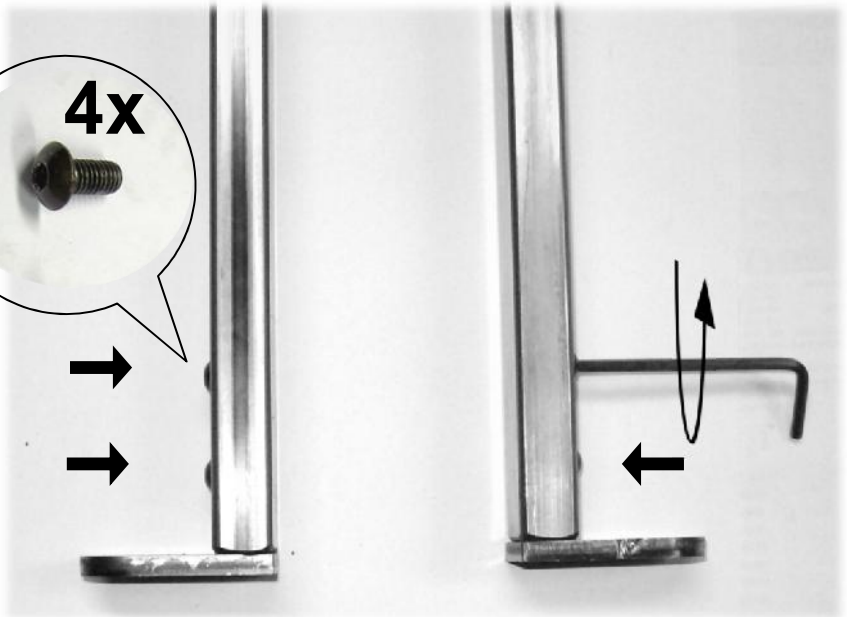

# 5

IT  
EN  
FR  
DE  
ES  
RU



N° 3

1x



M5 x 25 TB

2x



1x



2x

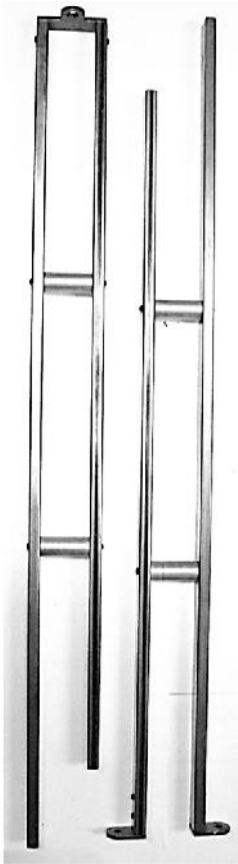

1x

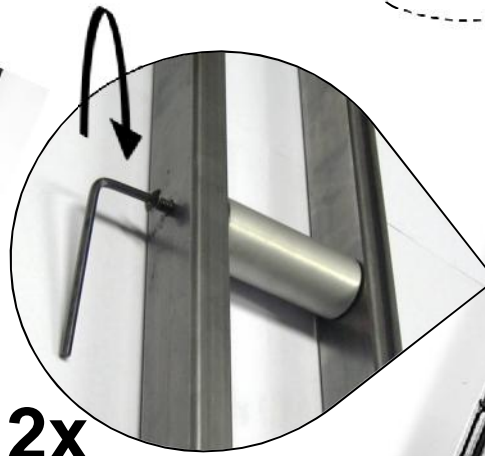
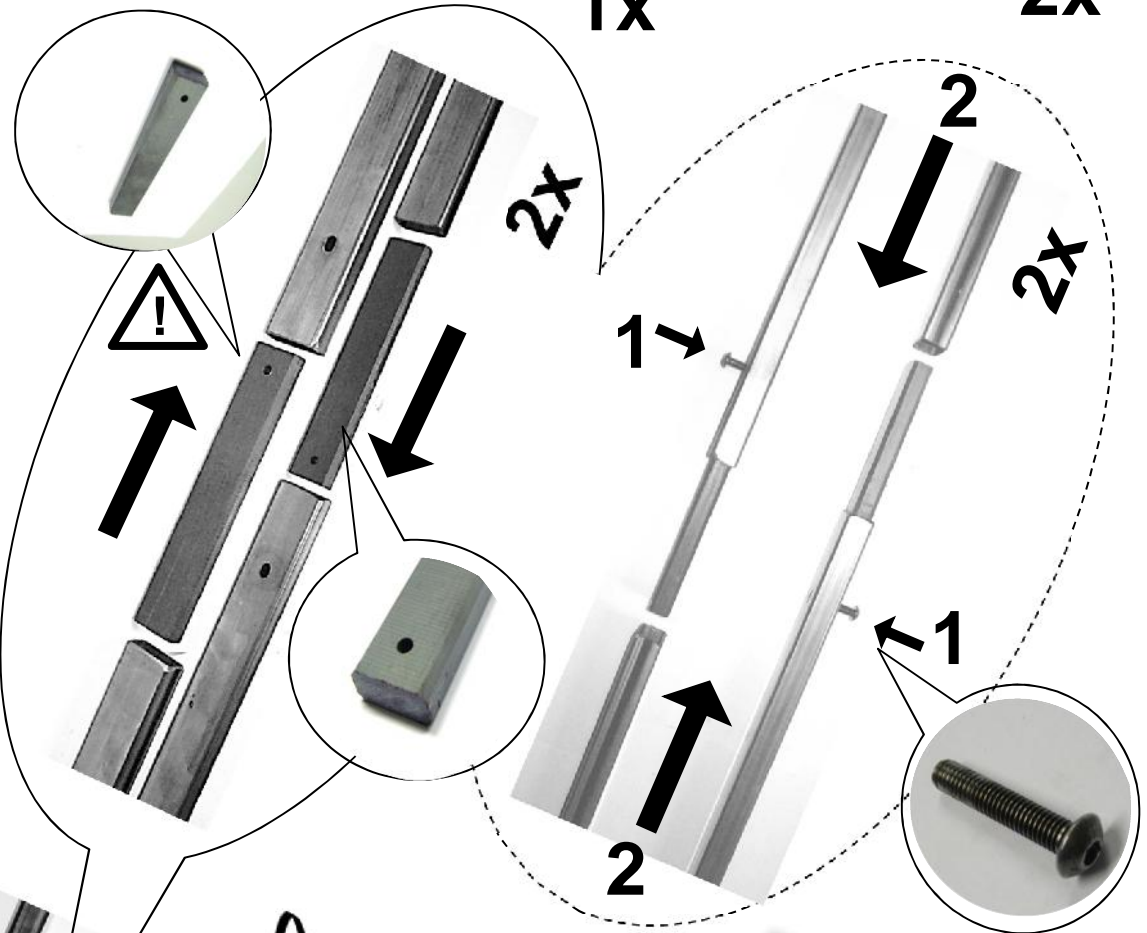

2x

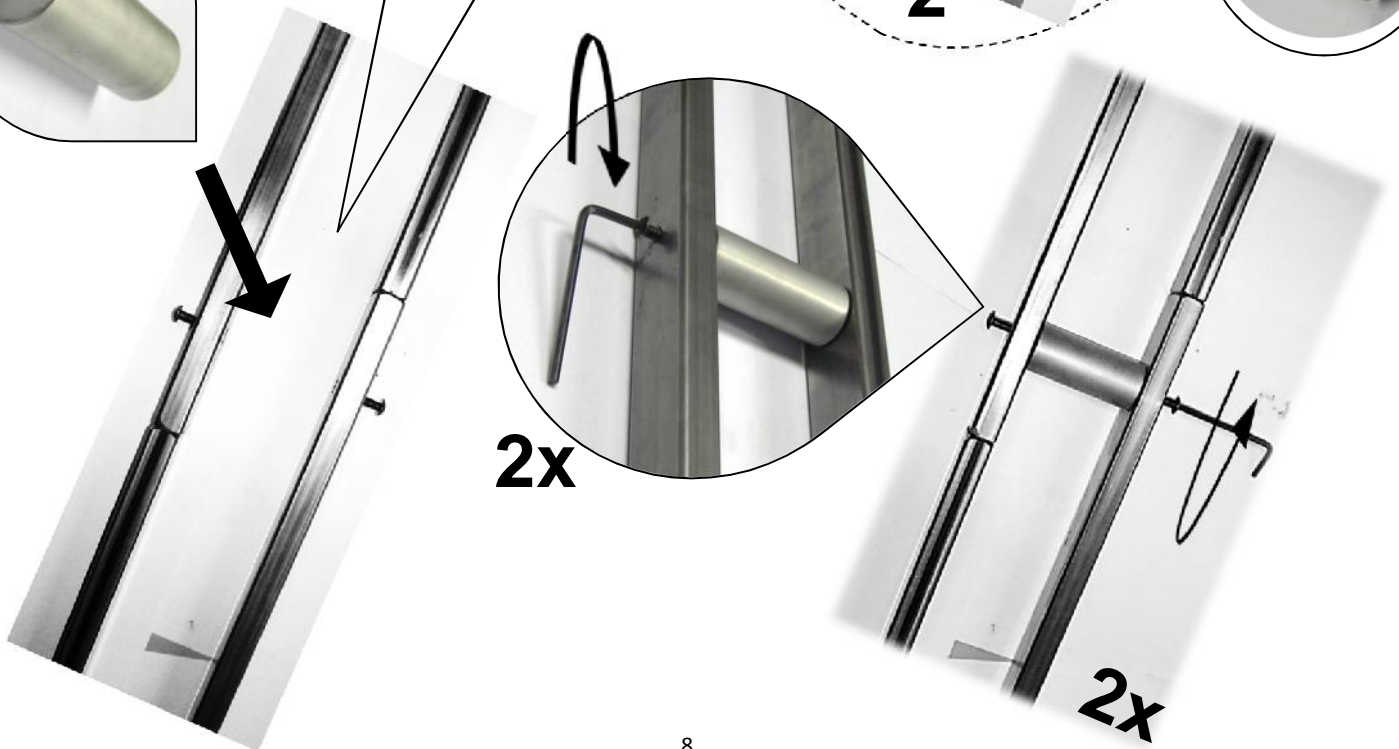

2x



# 6 SUPPORTO SCALA

SCALA STAND

SUPPORT SCALA

STÄNDER SCALA

SOPORTE SCALA

ПОДСТАВКА SCALA



N° 5

1x



M8 x 20 TS

2x



M8

2x

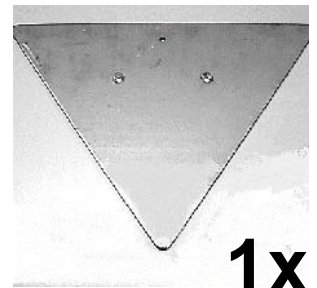

1x

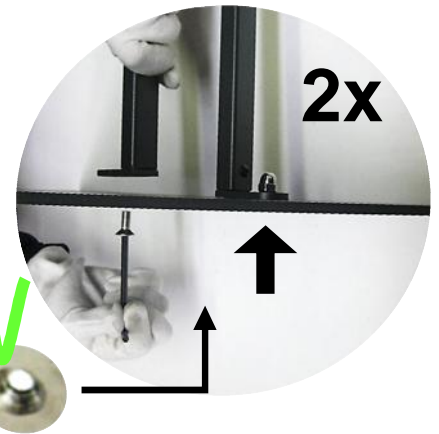
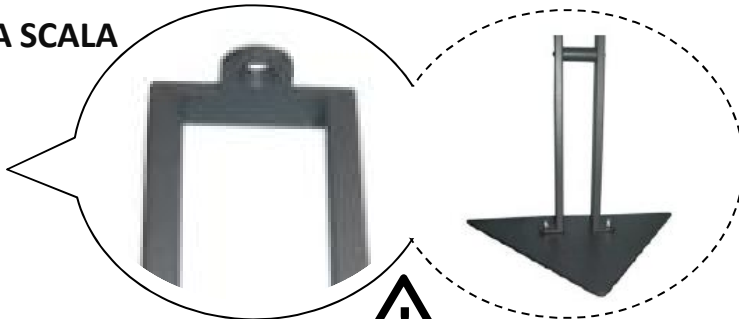

IT

A questo punto fissare la base triangolare utilizzando le n°2 viti M8x20 e i dadi ciechi M8, **PRESTANDO ATTENZIONE AD ORIENTARE LA PIASTRA PORTA RISCALDATORE NELLO STESSO VERSO DELLA PUNTA DEL TRIANGOLO DI BASE**, ottenendo infine il prodotto come nella foto d'insieme. Serrare infine tutte le viti M5x25.

EN

Then, secure the triangular base by using n° 2 M8x20 screws and the M8 cap nuts, **PAYING ATTENTION TO THE DIRECTION OF THE HEATER HOLDING PLATE THAT MUST BE THE SAME AS THE TOP POINT OF THE BASE TRIANGLE**, thus obtaining the product assembled as shown in the assembly picture. Lastly, tighten all the M5x25 screws.

FR

Fixer ensuite la base triangulaire en utilisant 2 vis M8x20 et les écrous borgnes M8, **EN FAISANT BIEN ATTENTION A ORIENTER LE SUPPORT DE FIXATION DE L'APPAREIL DANS LE MEME SENS QUE LA POINTE DU TRIANGLE DE LA BASE**, obtenant ainsi le produit comme sur la photo d'ensemble. Pour finir, bien serrer toutes les vis M5x25.

DE

Die dreieckige Base mit den 2 Schrauben M8x20 und den 2 Verschlussmüttern M8 befestigen; zu beachten ist, dass die Klemmplatte für den Heizstrahler oben in die gleiche Richtung der Spitze der dreieckigen Base orientiert wird, schließlich alle M5X25 Schrauben festziehen. Nach diesem Vorgang wird das Produkt wie in der nachstehenden Abbildung aussehen

ES

**ORIENTACIÓN DE LA PUNTA DE LA BASE DEL TRIÁNGULO /PLACA DE CALEFACCIÓN.** Ahora fijar la base triangular, utilizando los tornillos M8x20 n°2 y las tuercas ciegas M8, teniendo cuidado que la placa de calefacción sea orientada en la misma dirección de la punta de la base triangular, consiguiendo al final el producto como en la foto final. Después, apretar todos los tornillos M5x25 n°10.





**RU** На следующем этапе сборки закрепите треугольное основание, используя №2 винта М8Х20 и глухие гайки М8, **обращая внимание на положение пластины, на которую будут крепиться** Данная пластина должна быть направлена в том же направлении, в котором располагается вершина треугольника пьедестала базовой части подставки, как на совместном фото. Завинтите до самого конца все винты М5Х25.



**IT** In caso si voglia fissare il supporto scala al pavimento con tasselli ad espansione, utilizzare il foro centrale della base triangolare.

**EN** If you need a firm position, anchor the basis to the floor putting an appropriate anchor plug in the hole that is in the central part of the triangular basis.

**FR** Si l'on veut fixer le support SCALA au sol avec des chenilles à expansion, il faudra utiliser le trou central de la base triangulaire.

**DE** Das Mittelloch der dreieckigen Basis verwenden, falls Sie den Ständer Scala durch Dehnschrauben fest am Boden einbauen möchten.

**ES** Si necesita una posición firme, anclar la base al suelo poniendo una clavija apropiada en el orificio que se encuentra en la parte central de la base triangular.

**RU** При желании подставка Scala может быть прикреплена к полу, для чего используйте дюбели и центральное отверстие на пьедестале треугольной базы.

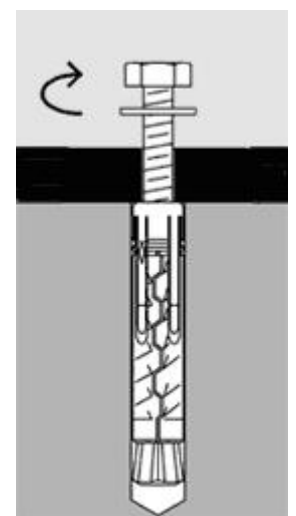

- **Accessorio in metallo per l'aggancio di n. 2 apparecchi contrapposti**
- **Metallic accessory to couple two opposite heaters**
- **Accessoire en métal pour l'installation de nr.2 appareils opposés**
- **Halterung aus Metall zum Ankuppeln von 2 gegenüberstehenden Geräten**
- **Acesorio en metal para el enganche de n° 2 aparatos contrapuestos**

2

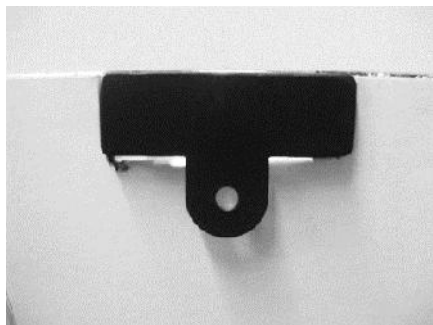

- FOTO 1. PARTE SUPERIORE DELLA SCALA
- PICTURE 1. UPPER PART OF SCALA STAND
- PHOTO 1. PARTIE SUPERIEURE DE LA SCALA
- PHOTO 1: OBERTEIL DER SCALA
- FOTO 1 PARTE SUPERIOR DE LA SCALA
- 1. SCALA



- FOTO 2: SUPPORTO METALLICO DA APPLICARE
- PICTURE 2. METAL BRACKET TO BE PLACED
- PHOTO 2: SUPPORT METALLIQUE A APPLIQUER
- PHOTO 2: ZU VERWENDENDE METALLSTÜTZE
- FOTO 2 SOPORTE METÁLICO PARA APLICAR
- 2.

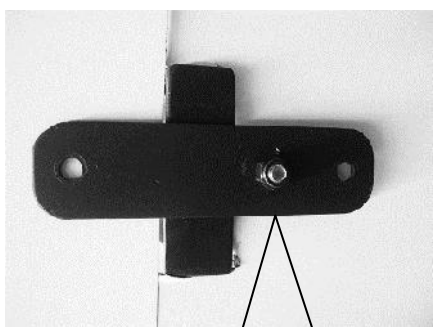

- FOTO 3: COME VANNO ASSEMBLATI I 2 PEZZI
- PICTURE 3. HOW TO ASSEMBLE THE TWO PARTS
- PHOTO 3: ASSEMBLAGE DES 2 PIECES
- PHOTO 3: ZUSAMMENBAU DER BEIDEN TEILE
- FOTO 3 CÓMO SE ENSAMBLAN LAS PIEZAS
- 3. 2

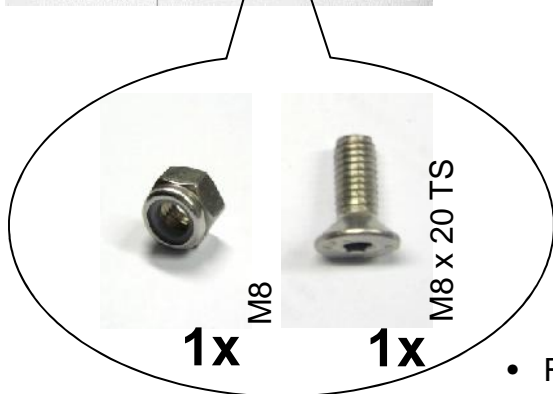

- RISULTATO FINALE
- FINAL RESULT
- RESULTAT FINAL
- ENDERGEBNIS
- RESULTADO FINAL
- 





**ATTENZIONE ! WARNING !  
AVVERTISSEMENT ! ACHTUNG !  
ADVERTENCIA ! ВНИМАНИЕ !**

**Non spostare quando acceso,  
il bulbo si danneggia!**

**Do not move when turned on,  
the bulb gets damaged!**

**Ne pas déplacer si il est allumé,  
afin de ne pas endommager la  
lampe!**

**Das eingeschaltete Gerät nicht  
bewegen, um Schäden an der  
Lampe zu verhindern!**

**No desplazar cuando está  
encendido,  
la bombilla se perjudica!**

**НЕ ПЕРЕМЕЩАТЬ ВКЛЮЧЕННОЕ  
ОБОРУДОВАНИЕ,  
ПОВРЕЖДАЕТСЯ ЛАМПА!**

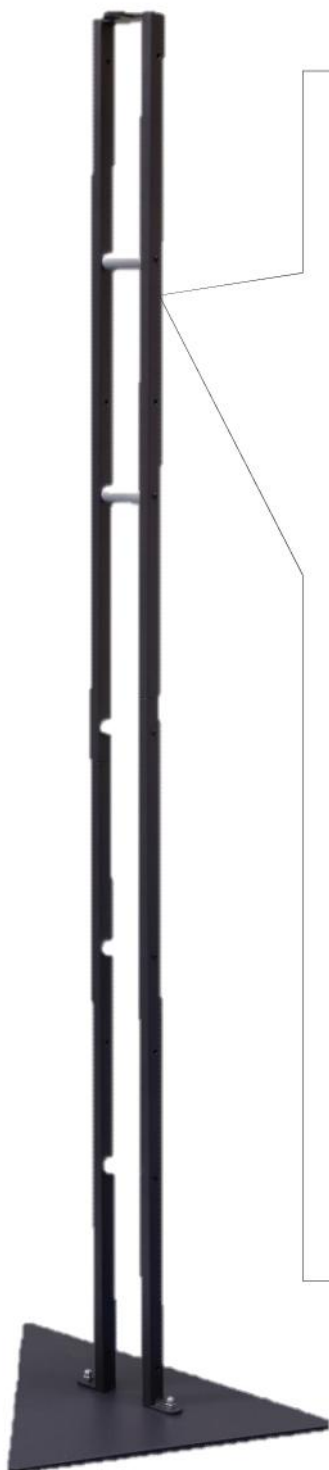

Дистрибьютор Heliosa:

«Мир Нагрева»

[www.MirNagreva.ru](http://www.MirNagreva.ru)

+7 (495) 798-27-55 (все регионы)

+7 (495) 790-50-34 (г. Москва)

+7 (812) 984-69-26 (г. Санкт-Петербург)

+7 (8452) 37-44-39 (г. Саратов)

8 (800) 444-73-69 (бесплатно по РФ)

Viber, What's Up: +7 (968) 626 10 24



**SEDE CENTRALE – PRODUZIONE / HEADQUARTERS - PRODUCTION**

**STAR PROGETTI Technologie Applicate SpA**

Via Pasubio 4/D 20067 TRIBIANO (MI) ITALY Tel +39 02 90 63 92 61 Fax +39 02 90 63 92 59

[www.starprogetti.com](http://www.starprogetti.com) - [info@starprogetti.com](mailto:info@starprogetti.com)

**STAR PROGETTI FRANCE S.A.R.L.**

345, Rue du Bois Bernoux - 71290 CUISERY - FRANCE TEL. 03 85 40 12 62 FAX 03 85 40 06 91

[www.starprogetti.com](http://www.starprogetti.com) - [starprogetti@aol.com](mailto:starprogetti@aol.com)